











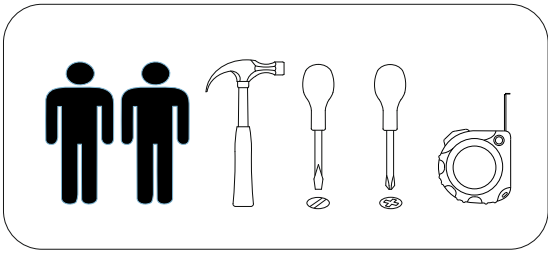

Ронда ШКУ



| | | |
|---|---|---|
|  |  |  |
| 870 | 2120 | 870 |

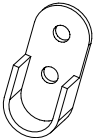
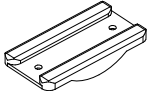

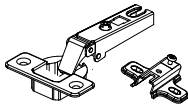
- 30x 
- 30x 
- 1x 
- 8x 
- 21x 
- 100x 
- 12x 
- 2x 
- 6x 
- 1x 
- 3x 

12

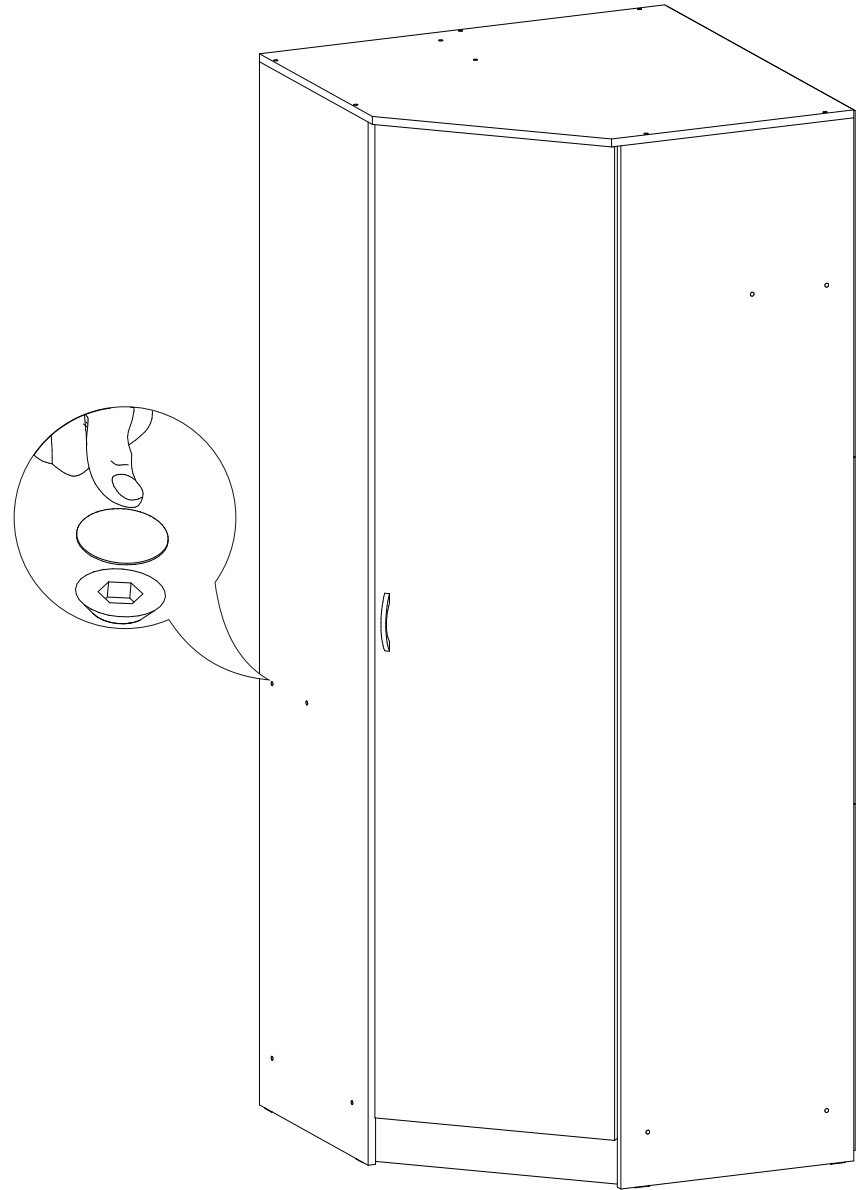

11

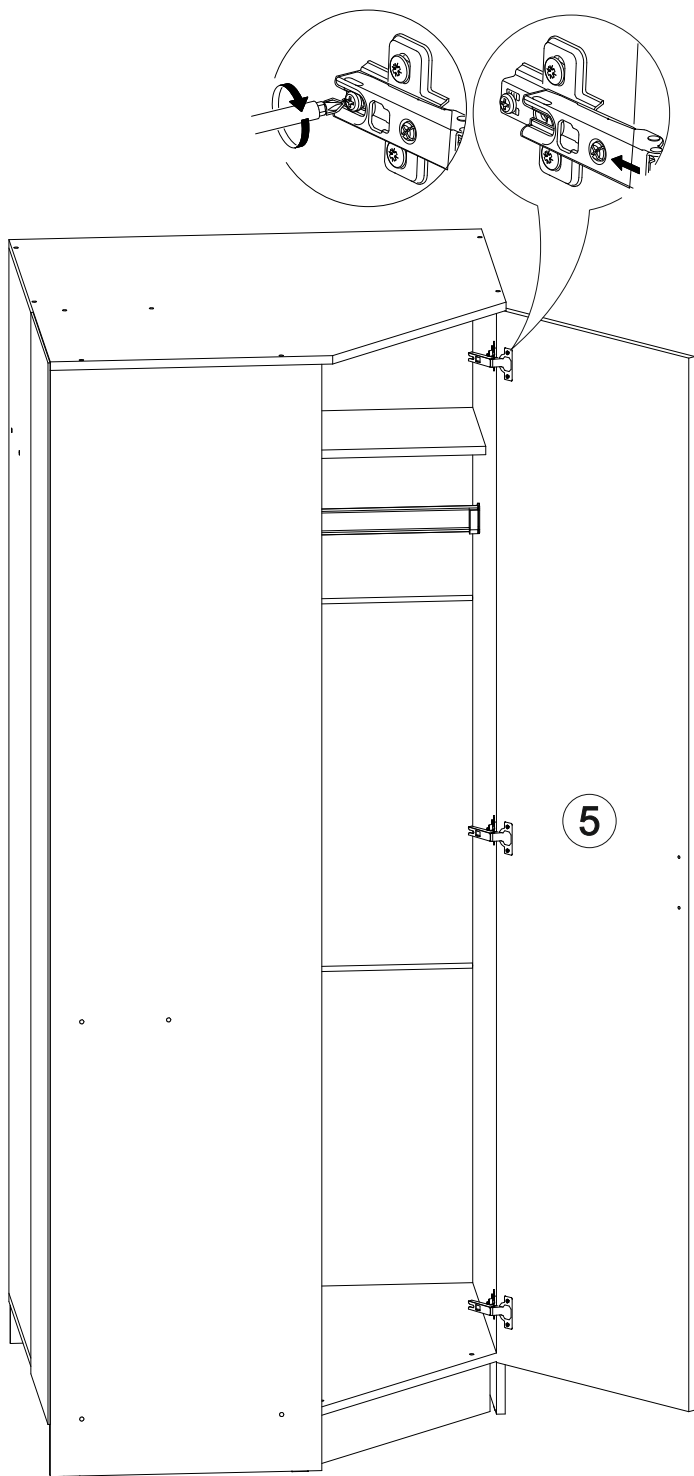

| № дет. | Деталь/Detail | Размер/Size | Кол-во/ Quantity | № упак./ № pack |
|--------|-----------------------------|-------------|---------------------|--------------------|
| 1 | Бок левый/Side left | 2100x500 | 1 | 1/3 |
| 2 | Бок правый/Side right | 2100x500 | 1 | 1/3 |
| 3 | Перегородка/Side middle | 1984x500 | 1 | 1/3 |
| 4 | Перегородка/Side middle | 1984x276 | 1 | 1/3 |
| 5 | Фасад/Front | 2000x496 | 1 | 1/3 |
| 6 | Задняя стенка ДВП/Back side | 2015x360 | 1 | 1/3 |
| 7 | Крышка скошенная/Top | 870x870 | 1 | 2/3 |
| 8 | Вязка скошенная/Binding | 854x854 | 1 | 2/3 |
| 9-10 | Цоколь/Socle | 520x100 | 2 | 2/3 |
| 11 | Вязка/Connecting element | 838x276 | 1 | 2/3 |
| 12 | Вязка/Connecting element | 338x276 | 1 | 2/3 |
| 13-15 | Полка/Shelf | 338x276 | 3 | 2/3 |
| 16-18 | Задняя стенка ДВП/Back side | 865x697 | 3 | 2/3 |
| 19-20 | Соединитель/Connector | 837 | 2 | 2/3 |
| 21 | Штанга/Oval tube | 833 | 1 | 2/3 |

1

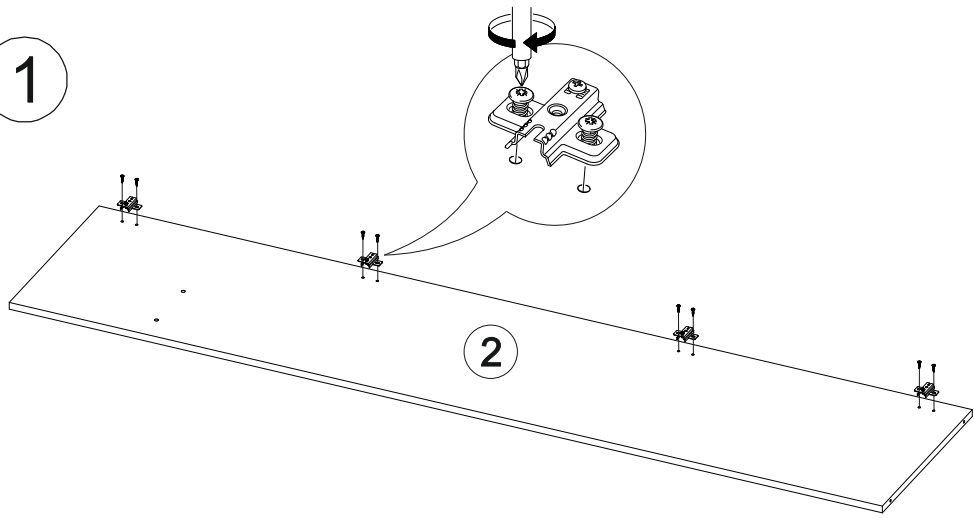

2

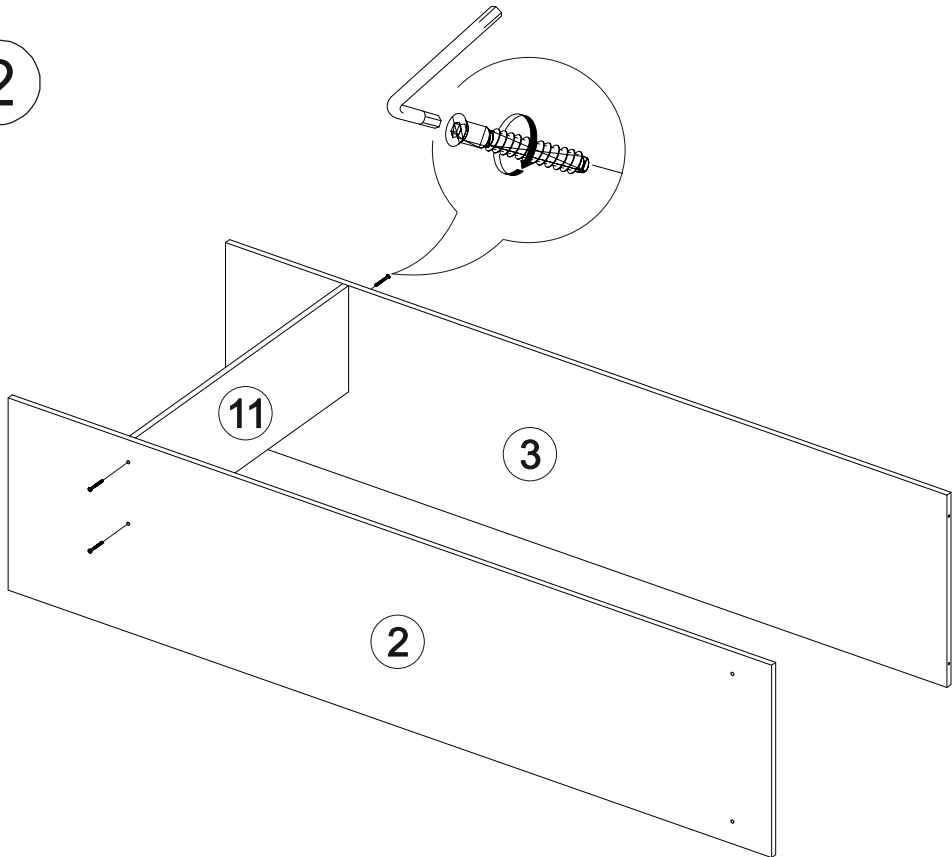

10

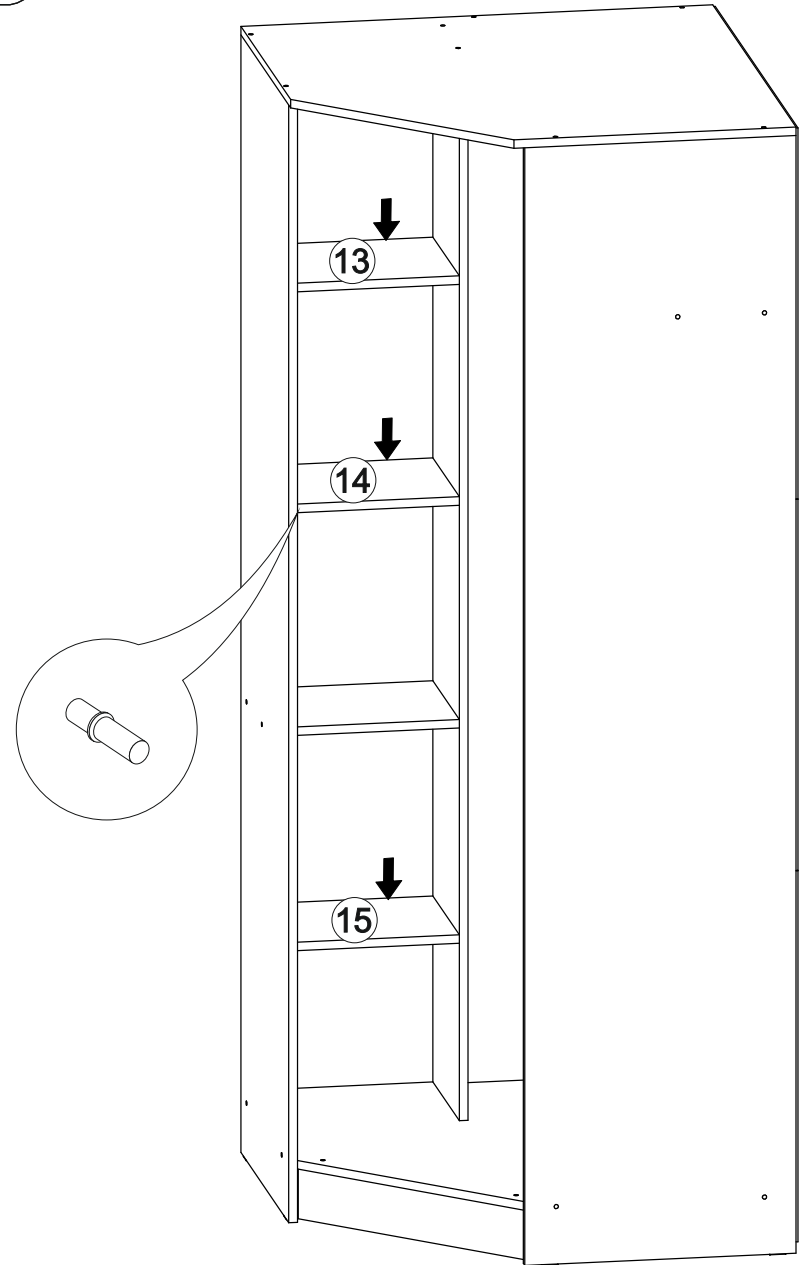

9

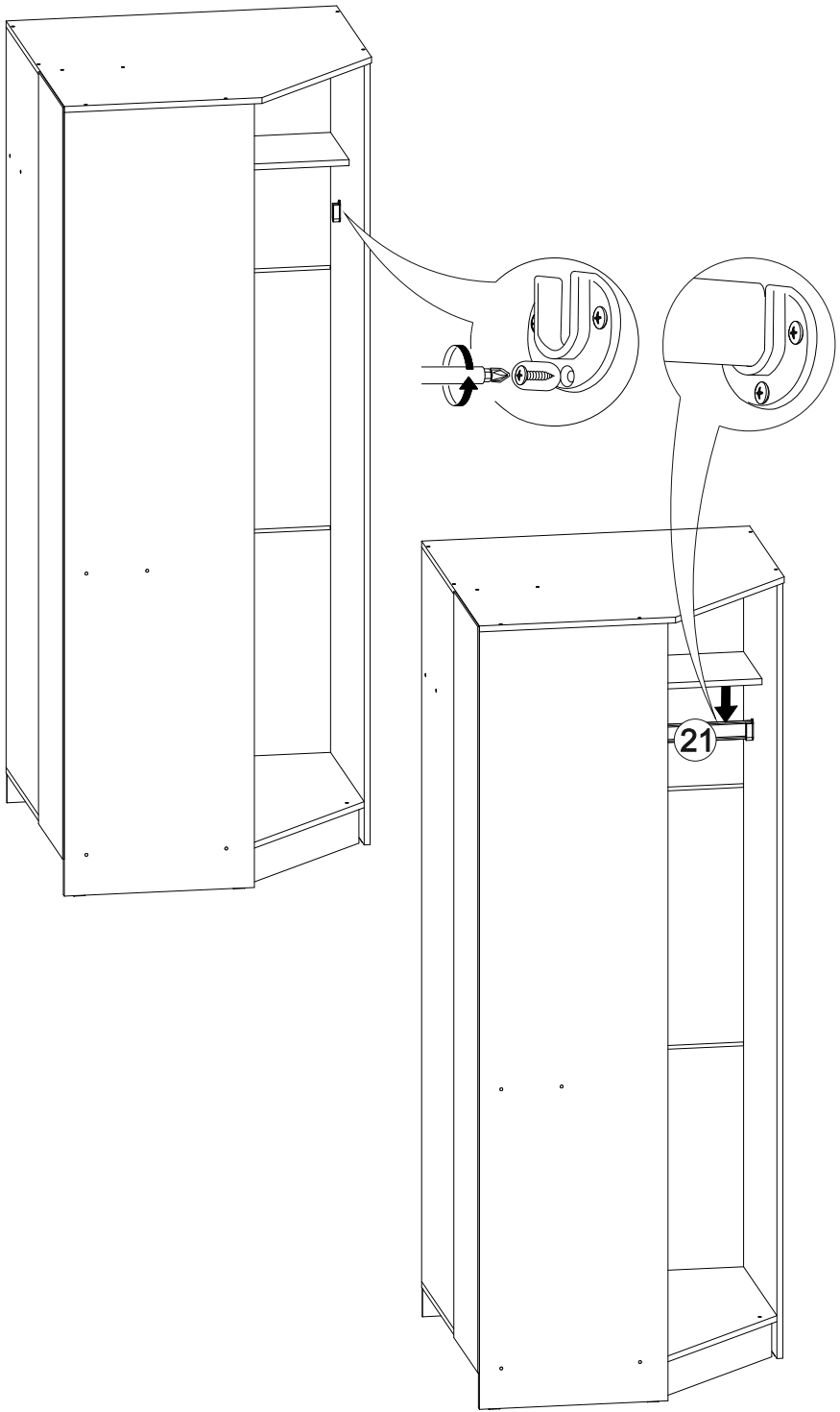

3

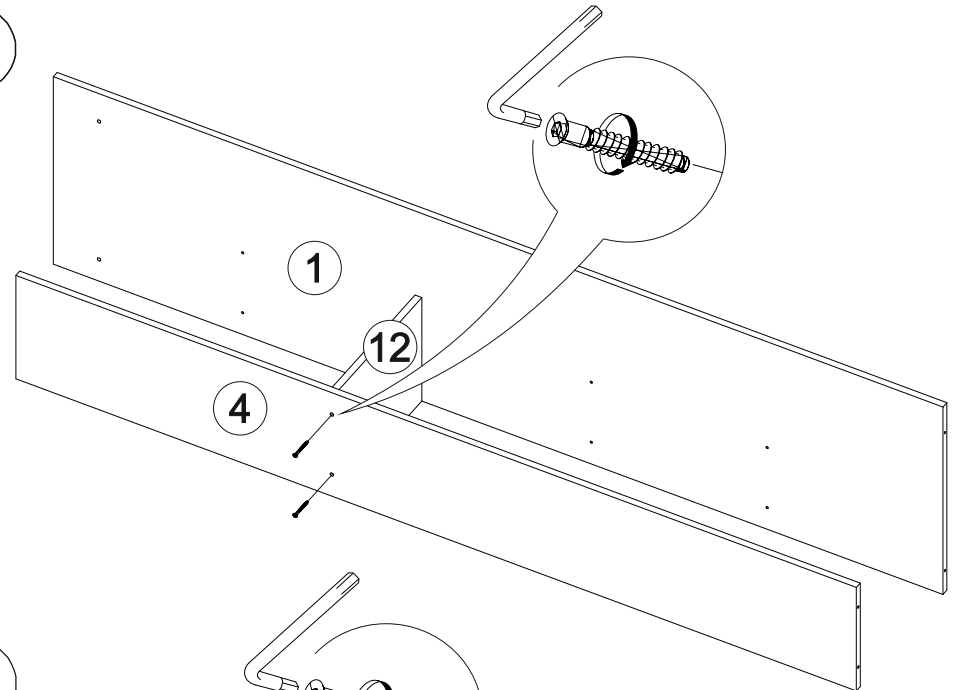

4

